

N

Hoses & Fittings

Tubi e raccordi



Specifications / Specifiche: SAE J2064 Type A Class I

Continuous working temperature / Temperatura di lavoro: -40°C / +115°C



One piece fitting / Pezzo unico

GLACIER Normal hose section / Tubo a sezione normale

Part. Codice	Hose size Dim. tubo			I.D. mm	O.D. mm	Max Work Pressure Max pressione lavoro bar	Burst Pressure Pressione di scoppio bar	Weight Peso g/m	Min. Bend radius Raggio min. di piega mm
	DN	Dash	Inch						
T01110011-A/C	8	6	5/16"	8	18.5	35	160	260	60
T01110010-A/C	10	8	13/32"	10.05	22	35	160	360	80
T01110009-A/C	12	10	1/2"	12.07	24	35	160	410	95



Specifications / Specifiche: SAE J2064 Type C Class I

Continuous working temperature / Temperatura di lavoro: -40°C / +135°C



One piece fitting / Pezzo unico

GALAXY 4890 SLE Reduced hose section / Tubo a sezione ridotta

Part. Codice	Hose size Dim. tubo			I.D. mm	O.D. mm	Max Work Pressure Max pressione lavoro bar	Burst Pressure Pressione di scoppio bar	Weight Peso kg/m	Min. Bend radius Raggio min. di piega mm
	DN	Dash	Inch						
T01110022-A/C SR	8	6	5/16"	7.9	15.2	34	137	0.13	25
T01110024-A/C SR	10	8	13/32"	10.2	17.8	34	137	0.18	38
T01110023-A/C SR	12	10	1/2"	12.5	19.9	34	137	0.19	63
T01110021-A/C SR	14	12	5/8"	15.6	23.1	24	120	0.30	104

Straight o-ring female fitting Raccordo femmina dritta o-ring

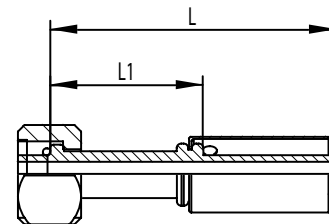

Code Codice	Hose size 1 Dim. tubo 1	Threading Filettatura	L ±2.5	±2.5 L1	±2.5 L2	H±2.5	V±2.0	W
106SR069	06-5/16"	5/8"-18-UNF-2B	62	33.3				19
106RR019	06-5/16"	5/8"-18-UNF-2B	61.5	34.3				19
108SR095	08-13/32"	3/4"-16-UNF-2B	66.5	36.3				22
108RR059	08-13/32"	3/4"-16-UNF-2B	66.5	36.3				22
108SR155*	08-13/32"	1"-14-UNS-2B	66.0	35.8				29
110SR002	10-1/2"	7/8"-14-UNF-2B	68.0	37.3				27
110RR111	10-1/2"	7/8"-14-UNS-2B	68.0	37.3				27
112SR002	12-5/8"	7/8"-14-UNF-2B	69.0	37.0				27
112SR155*	12-5/8"	1"-14-UNS-2B	79.0	47.0				29

* = Rotalock

Straight o-ring female fitting with high pressure valve Raccordo femmina dritta o-ring con valvola alta pressione

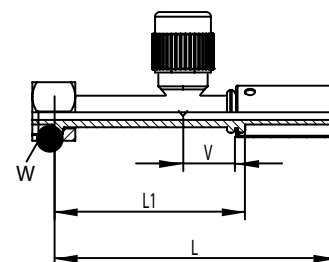

Code Codice	Hose size 1 Dim. tubo 1	Threading Filettatura	L ±2.5	±2.5 L1	±2.5 L2	H±2.5	V±2.0	W
106SR039	06-5/16"	5/8"-18-UNF-2B	87.5	60.3			16.4	19
106RR122	06-5/16"	5/8"-18-UNF-2B	86.0	58.8			16.0	19
108SR003	08-13/32"	3/4"-16-UNF-2B	83.0	52.8			16.0	22
108SR010*	08-13/32"	1"-14-UNS-2B	75.0	44.8			16.0	29
108RR010*	08-13/32"	1"-14-UNS-2B	75.0	44.8			16.0	29

* = Rotalock

Straight o-ring female fitting with low pressure valve raccordo femmina dritta o-ring con valvola bassa pressione

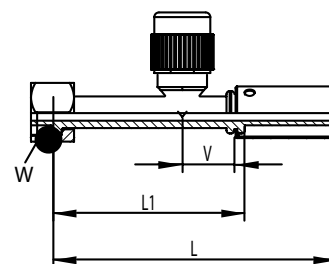

Code Codice	Hose size 1 Dim. tubo 1	Threading Filettatura	L ±2.5	±2.5 L1	±2.5 L2	H±2.5	V±2.0	W
110SR003	10-1/2"	7/8"-14-UNF-2B	81.5	50.8			16.0	27
110RR112	10-1/2"	7/8"-14-UNF-2B	81.5	50.8			16.0	27
110SR047*	10-1/2"	1"-14-UNS-2B	79.0	48.3			16.0	29
110RR047*	10-1/2"	1"-14-UNS-2B	79.0	48.3			16.0	29
112SR002	12-5/8"	7/8"-14-UNF-2B	81.0	49.0			16.0	27
112SR155*	12-5/8"	1"-14-UNS-2B	79.0	47.0			16.0	29

* = Rotalock

45° Elbow o-ring female fitting Raccordo femmina o-ring 45°

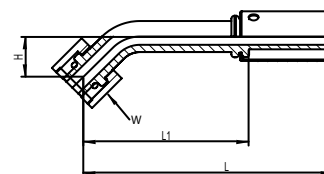

Code Codice	Hose size 1 Dim. tubo 1	Threading Filettatura	Threading 2 Filettatura 2	L ±2.5	±2.5 L1	±2.5 L2	H±2.5	V±2.0	W
106SR084	06-5/16"	5/8"-18-UNF-2B		81.8	54.4		13.5		19
106RR026	06-5/16"	5/8"-18-UNF-2B		80.0	52.8		12.5		19
108SR097	08-13/32	3/4"-16-UNF-2B		88.0	57.8		13.5		22
108RR076	08-13/32	3/4"-16-UNF-2B		88.0	57.8		13.5		22
108SR219*	08-13/32"	1"-14-UNS-2B		85.0	54.8		14.0		29
108RR029*	08-13/32"	1"-14-UNS-2B		85.0	54.8		14.0		29
110SR019	10-1/2"	7/8"-14-UNF-2B		99.0	68.3		24.0		27
110RR127	10-1/2"	7/8"-14-UNF-2B		99.0	68.3		24.0		27
110SR139*	10-1/2"	1"-14-UNS-2B		98.0	67.3		22.0		29
110RR071*	10-1/2"	1"-14-UNS-2B		98.0	67.3		22.0		29
112SR019	12-5/8"	7/8"-14-UNF-2B		99.0	67.0		24.0		27

* = Rotalock

45° Elbow o-ring female fitting with high pressure valve Raccordo femmina o-ring 45° con valvola alta pressione

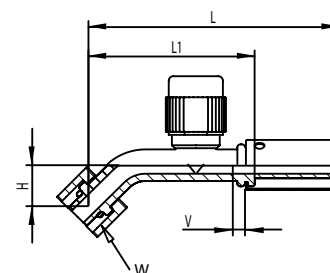

Code Codice	Hose size 1 Dim. tubo 1	Threading Filettatura	Threading 2 Filettatura 2	L ±2.5	±2.5 L1	±2.5 L2	H±2.5	V±2.0	W
106SR085	06-5/16"	5/8"-18-UNF-2B		80.0	52.8		12.5	16.0	19
108SR098	08-13/32"	3/4"-16-UNF-2B		88.0	57.8		13.5	16.0	22
108RR838	08-13/32"	3/4"-16-UNF-2B		88.0	57.8		13.5	16.0	22
108RR818*	08-13/32"	1"-14-UNS-2B		85.0	54.8		14.0	16.0	29

* = Rotalock

45° Elbow o-ring female fitting with low pressure valve Raccordo femmina o-ring 45° con valvola bassa pressione

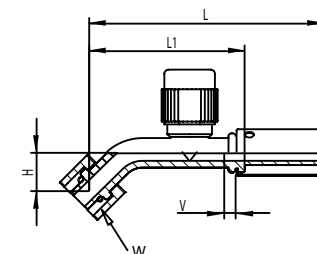

Code Codice	Hose size 1 Dim. tubo 1	Threading Filettatura	Threading 2 Filettatura 2	L ±2.5	±2.5 L1	±2.5 L2	H±2.5	V±2.0	W
110SR062	10-1/2"	7/8"-14-UNF-2B		99.0	68.3		24.0	16.0	27
110RR287*	10-1/2"	1"-14-UNS-2B		98.0	67.3		22.0	16.0	29
110RR126	10-1/2"	7/8"-14-UNF-2B		99.0	68.3		24.0	16.0	27

* = Rotalock

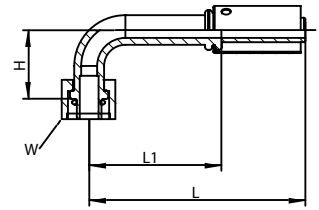

90° Elbow o-ring female fitting
Raccordo femmina o-ring 90°

Code Codice	Hose size 1 Dim. tubo 1	Threading Filettatura	Threading 2 Filettatura 2	L ±2.5	±2.5 L1	±2.5 L2	H±2.5	V±2.0	W
106SR032	06-5/16"	5/8"-18-UNF-2B		74.6	45.8		24.0		19
106SR032-01	06-5/16"	5/8"-18-UNF-2B		72.5	50.8		43.6		19
106RR001	06-5/16"	5/8"-18-UNF-2B		72.5	45.3		24.0		19
108SR026	08-13/32"	3/4"-16-UNF-2B		79.0	48.8		30.0		22
108RR004	08-13/32"	3/4"-16-UNF-2B		79.0	48.8		30.0		22
108SR162*	08-13/32"	1"-14-UNS-2B		78.0	47.8		33.0		29
108RR022	08-13/32"	1"-14-UNS-2B		78.0	47.8		33.0		29
110SR059	10-1/2"	7/8"-14-UNF-2B		92.0	61.3		46.5		27
110RR064	10-1/2"	7/8"-14-UNF-2B		92.0	61.3		46.5		27
110SR077*	10-1/2"	1"-14-UNS-2B		93.0	62.3		39.0		29
110RR054	10-1/2"	1"-14-UNS-2B		93.0	62.3		39.0		29
112SR059	12-5/8"	7/8"-14-UNF-2B		89.0	57.0		45.0		27
112SR077*	12-5/8"	1"-14-UNS-2B		92.5	60.5		38.0		29

* = Rotalock

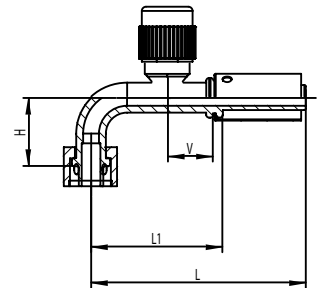

90° Elbow o-ring female fitting with high pressure valve
Raccordo femmina o-ring 90° con valvola alta pressione

Code Codice	Hose size 1 Dim. tubo 1	Threading Filettatura	Threading 2 Filettatura 2	L ±2.5	±2.5 L1	±2.5 L2	H±2.5	V±2.0	W
106SR033	06-5/16"	5/8"-18-UNF-2B		74.5	45.8		24.0	16.0	19
106RR337	06-5/16"	5/8"-18-UNF-2B		72.5	45.3		24.0	16.0	19
108SR142	08-13/32"	3/4"-16-UNF-2B		79.0	48.8		30.0	16.0	22
108RR142	08-13/32"	3/4"-16-UNF-2B		79.0	48.8		30.0	16.0	22
108SR061*	08-13/32"	1"-14-UNS-2B		79.5	49.3		32.0	16.0	29
108RR061*	08-13/32"	1"-14-UNS-2B		79.5	49.3		32.0	16.0	29

* = Rotalock

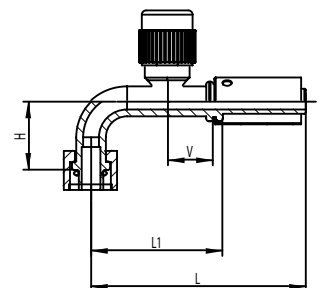

90° Elbow o-ring female fitting with low pressure valve
Raccordo femmina o-ring 90° con valvola bassa pressione

Code Codice	Hose size 1 Dim. tubo 1	Threading Filettatura	Threading 2 Filettatura 2	L ±2.5	±2.5 L1	±2.5 L2	H±2.5	V±2.0	W
110SR060	10-1/2"	7/8"-14-UNF-2B		92.0	61.3		46.5	16.0	27
110RR093	10-1/2"	7/8"-14-UNF-2B		92.0	61.3		46.5	16.0	27
110SR011*	10-1/2"	1"-14-UNS-2B		93.0	62.3		39.0	16.0	29

* = Rotalock

180° Elbow o-ring female fitting Raccordo femmina o-ring 180°

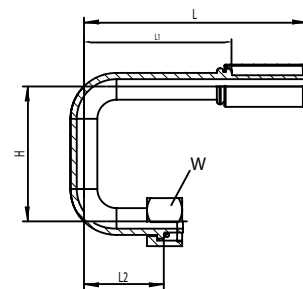

Code Codice	Hose size 1 Dim. tubo 1	Threading Filettatura	Threading 2 Filettatura 2	L ±2.5	±2.5 L1	±2.5 L2	H±2.5	V±2.0	W
106SR081	06-5/16"	5/8"-18-UNF-2B		85.0	57.8	32.4	50.0		19
106RR081	06-5/16"	5/8"-18-UNF-2B		85.0	57.8	32.4	50.0		19
108SR082	08-13/32"	3/4"-16-UNF-2B		90.0	59.8	30.0	65.0		22
108RR082	08-13/32"	3/4"-16-UNF-2B		90.0	59.8	30.0	65.0		22
108SR133*	08-13/32"	1"-14-UNS-2B		96.0	65.8	49.8	75.0		29
108RR133*	08-13/32"	1"-14-UNS-2B		96.0	65.8	49.8	75.0		29
110SR083	10-1/2"	7/8"-14-UNF-2B		96.0	65.3	49.0	48.0		27

* = Rotalock

(¹) = 1 curva - 1 bend

(²) = 2 curve a 90° - 2 x 90° bends

Straight fitting for expansion valve Raccordo dritto per valvola a espansione

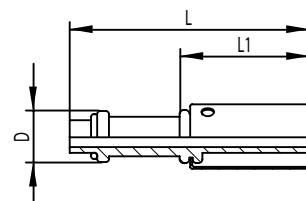

Code Codice	Hose size 1 Dim. tubo 1	Threading Filettatura	Threading 2 Filettatura 2	L ±2.5	±2.5 L1	±2.5 L2	H±2.5	V±2.0	Diameter Diametro
106SR021	06-5/16"	-		55.5	28.3				13 mm
106RR032	06-5/16"	-		55.5	28.3				13 mm
110SR008	10-1/2"	-		68.0	37.3				23 mm
110RR074	10-1/2"	-		68.0	37.3				23 mm
112SR008	12-5/8"	-		68.0	36.0				23 mm

45° Elbow fitting for expansion valve Raccordo 45° per valvola a espansione

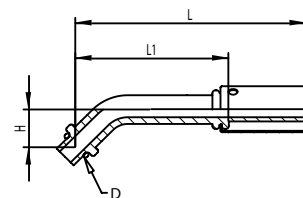

Code Codice	Hose size 1 Dim. tubo 1	Threading Filettatura	Threading 2 Filettatura 2	L ±2.5	±2.5 L1	±2.5 L2	H±2.5	V±2.0	Diameter Diametro
106SR030	06-5/16"	-		79.0	51.8		14.0		13 mm
106RR033	06-5/16"	-		79.0	51.8		14.0		13 mm
110SR031	10-1/2"	-		99.0	68.3		24.0		23 mm
110RR034	10-1/2"	-		99.0	68.3		24.0		23 mm
112SR031	12-5/8"	-		110.5	78.5		24.0		23 mm

30° Elbow fitting for expansion valve
Raccordo 45° per valvola a espansione

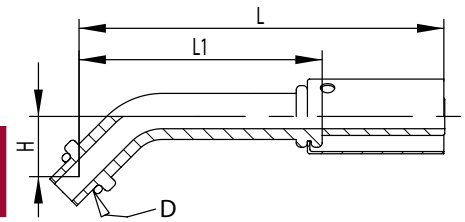

Code Codice	Hose size 1 Dim. tubo 1	Threading Filettatura	Threading 2 Filettatura 2	L ±2.5	±2.5 L1	±2.5 L2	H±2.5	V±2.0	Diameter Diametro
106SR120	06-5/16"	-		79.0	51.8		10.0		13

90° Elbow fitting for expansion valve
Raccordo 90° per valvola a espansione

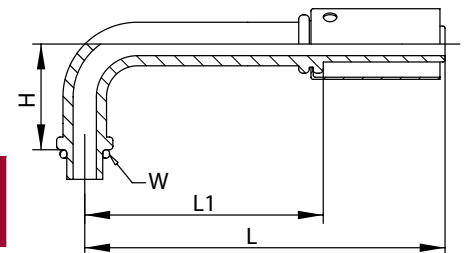

Code Codice	Hose size 1 Dim. tubo 1	Threading Filettatura	Threading 2 Filettatura 2	L ±2.5	±2.5 L1	±2.5 L2	H±2.5	V±2.0	Diameter Diametro
106SR014	06-5/16"	-		86.0	58.8		24.0		13
106RR049	06-5/16"	-		86.0	58.8		24.0		13
110SR027	10-1/2"	-		94.5	63.8		42.5		23
110RR012	10-1/2"	-		94.5	63.8		42.5		23
112SR027	12-5/8"	-		100.0	68.0		44.0		23

180° Elbow fitting for expansion valve
Raccordo 180° per valvola a espansione

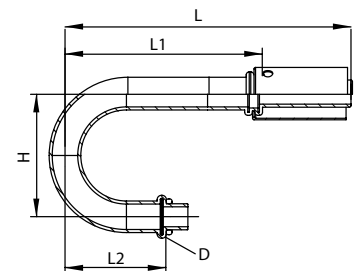

Code Codice	Hose size 1 Dim. tubo 1	Threading Filettatura	Threading 2 Filettatura 2	L ±2.5	±2.5 L1	±2.5 L2	H±2.5	V±2.0	Diameter Diametro
106SR357	06-5/16"	-		93	64.5	33	40.0		13
106RR357	06-5/16"	-		96.0	68.8	47.5	40.0		13
110SR358	10-1/2"	-		102.0	71.3	41.7	50.0		23
110RR358	10-1/2"	-		102.0	71.3	41.7	50.0		23
112SR358	12-5/8"	-		102.0	70.0	41.7	52.0		23

Connection fitting with high pressure valve
Congiunzione dritta con valvola alta pressione

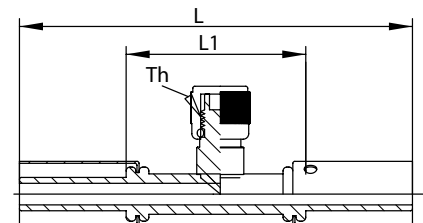

Code Codice	Hose size 1 Dim. tubo 1	Threading Filettatura	Threading 2 Filettatura 2	L ±2.5	±2.5 L1	±2.5 L2	H±2.5	V±2.0	Diameter Diametro
106SR023	06-5/16"			10.0	47				
106RR023	06-5/16"			98.0	43.6				
108SR188	08-13/32"			100.0	39.6				
108RR078	08-13/32"			100.0	39.6				

Connection fitting with low pressure valve
Congiunzione dritta con valvola bassa pressione

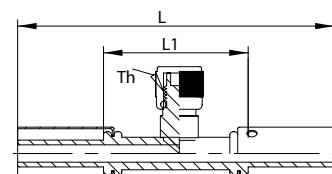

Code Codice	Hose size 1 Dim. tubo 1	Threading Filettatura	Threading 2 Filettatura 2	L ±2.5	±2.5 L1	±2.5 L2	H±2.5	V±2.0	W
110RR065	10-1/2"			102.0	40.6				
110SR065	10-1/2"			102.0	40.6				
112SR065	12-5/8"			104.0	40.0				

Straight connection with pressure switch
Congiunzione dritta con valvola pressostato

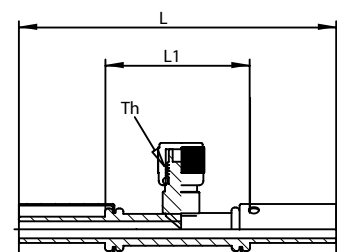

Code Codice	Hose size 1 Dim. tubo 1	Threading Filettatura	Threading 2 Filettatura 2	L ±2.5	±2.5 L1	±2.5 L2	H±2.5	V±2.0	W
106SR901	06-5/16"		7/16" 20 UNF	98.0	43.6				
106RR901	06-5/16"		7/16" 20 UNF	98.0	43.6				

Straight connection with pressure linear
Congiunzione dritta con valvola pressostato lineare

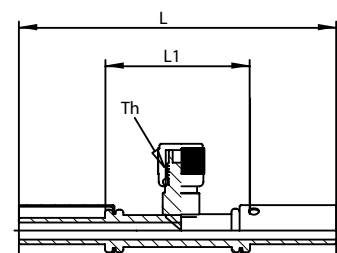

Code Codice	Hose size 1 Dim. tubo 1	Threading Filettatura	Threading 2 Filettatura 2	L ±2.5	±2.5 L1	±2.5 L2	H±2.5	V±2.0	W
106SR902	06-5/16"		M10x1.25	98.0	43.6				

Compact fitting o-ring female
Raccordo femmina compatta o-ring 90°

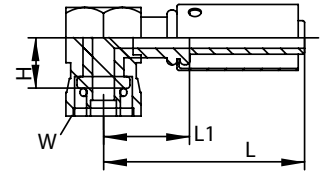

Code Codice	Hose size 1 Dim. tubo 1	Threading Filettatura	Threading 2 Filettatura 2	L ±2.5	±2.5 L1	±2.5 L2	H±2.5	V±2.0	W
106SR056	06-5/16"	5/8"-18-UNF-2B		47.0	17.5		12.9		19
106RR039	06-5/16"	5/8"-18-UNF-2B		47.0	17.5		12.9		19
108SR108	08-13/32"	5/8"-18-UNF-2B		51.0	18.0		12.9		19
108SR053	08-13/32"	3/4"-16-UNF-2B		52.0	19.0		16.0		22
108RR051	08-13/32"	3/4"-16-UNF-2B		52.0	19.0		16.0		22
108SR058*	08-13/32"	1"-14-UNS-2B		55.5	22.5		16.4		29
108RR058*	08-13/32"	1"-14-UNS-2B		55.5	22.5		16.4		29
110SR007	10-1/2"	7/8"-14-UNF-2B		55.0	21.5		16.4		27
110RR105	10-1/2"	7/8"-14-UNF-2B		55.0	21.5		16.4		27
110SR006*	10-1/2"	1"-14-UNS-2B		56.0	22.5		16.4		29
110RR006*	10-1/2"	1"-14-UNS-2B		56.0	22.5		16.4		29
112SR007	12-5/8"	7/8"-14-UNF-2B		58.0	23.2		16.4		27
112SR006*	12-5/8"	1"-14-UNS-2B		59.0	24.2		16.4		29

* = Rotalock

Compact fitting o-ring female with high pressure valve
Raccordo femmina compatta o-ring 90° con valvola alta pressione

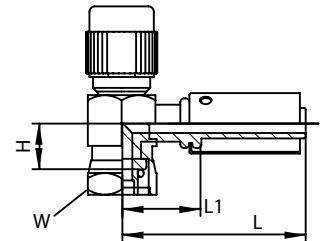

Code Codice	Hose size 1 Dim. tubo 1	Threading Filettatura	Threading 2 Filettatura 2	L ±2.5	±2.5 L1	±2.5 L2	H±2.5	V±2.0	W
106SR057	06-5/16"	5/8"-18-UNF-2B		47.0	17.5		12.9		19
106RR040	06-5/16"	5/8"-18-UNF-2B		47.0	17.5		12.9		19
108SR055	08-13/32"	3/4"-16-UNF-2B		52.2	19.2		16.0		22
108SR036*	08-13/32"	1"-14-UNS-2B		55.7	22.7		16.4		29
108RR036*	08-13/32"	1"-14-UNS-2B		55.7	22.7		16.4		29

Compact fitting o-ring female with high pressure valve
Raccordo femmina compatta o-ring 90° con valvola alta pressione

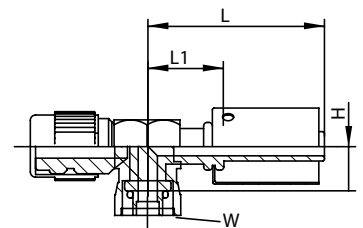

Code Codice	Hose size 1 Dim. tubo 1	Threading Filettatura	Threading 2 Filettatura 2	L ±2.5	±2.5 L1	±2.5 L2	H±2.5	V±2.0	W
106RR674	06-5/16"	5/8"-18-UNF-2B		47.0	17.5		12.9		19
108RR038*	08-13/32"	1"-14-UNS-2B		55.5	22.5		16.4		29

Compact fitting o-ring female with low pressure valve
Raccordo femmina compatta o-ring con valvola bassa pressione

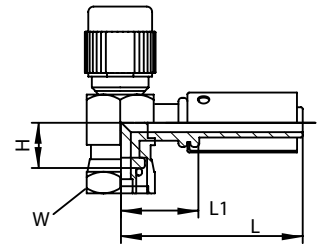

Code Codice	Hose size 1 Dim. tubo 1	Threading Filettatura	Threading 2 Filettatura 2	L ±2.5	±2.5 L1	±2.5 L2	H±2.5	V±2.0	W
110SR128	10-1/2"	7/8"-14-UNF-2B		55.0	21.5		16.4		27
110RR128	10-1/2"	7/8"-14-UNF-2B		55.0	21.5		16.4		27
110SR035*	10-1/2"	1"-14-UNS-2B		56.2	22.7		16.4		29
110RR035	10-1/2"	1"-14-UNS-2B		56.2	22.7		16.4		29
112SR128	12-5/8"	7/8"-14-UNF-2B		58.0	23.2		16.4		27
112SR035*	12-5/8"	1"-14-UNS-2B		59.0	24.2		16.4		29

* = Rotalock

Compact fitting o-ring female with low pressure valve
Raccordo femmina compatta o-ring con valvola bassa pressione

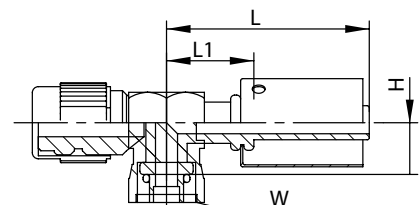

Code Codice	Hose size 1 Dim. tubo 1	Threading Filettatura	Threading 2 Filettatura 2	L ±2.5	±2.5 L1	±2.5 L2	H±2.5	V±2.0	W
110RR037	10-1/2"	7/8"-14-UNF-2B		55.2	21.7		16.4		27

Compact fitting o-ring female with low charge valve
Raccordo femmina compatta o-ring con valvola di carica

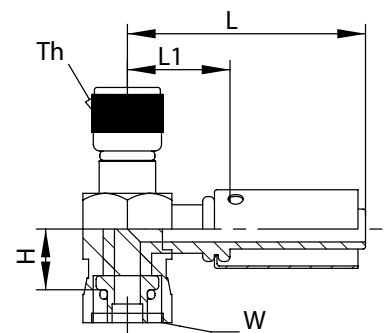

Code Codice	Hose size 1 Dim. tubo 1	Threading Filettatura	Threading 2 Filettatura 2	L ±2.5	±2.5 L1	±2.5 L2	H±2.5	V±2.0	W
106SR038	06-5/16"	5/8"-18-UNF-2B	7/16" 20 UNF	47.0	17.5		12.9		19
106RR038	06-5/16"	5/8"-18-UNF-2B	7/16" 20 UNF	47.0	17.5		12.9		19

Straight o-ring swivel male fitting
Raccordo maschio o-ring girevole dritto

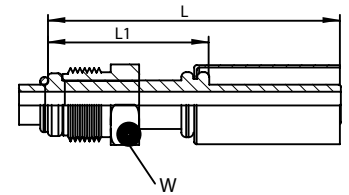

Code Codice	Hose size 1 Dim. tubo 1	Threading Filettatura	Threading 2 Filettatura 2	L ±2.5	±2.5 L1	±2.5 L2	H±2.5	V±2.0	W
106SR050	06-5/16"	5/8"-18-UNF-2A		63.0	35.8				17
106RR050	06-5/16"	5/8"-18-UNF-2A		63.0	35.8				17
110SR221	10-1/2"	7/8"-18-UNS-2A		72.0	41.3				22
110RR221	10-1/2"	7/8"-18-UNS-2A		72.0	41.3				22
112SR221-00	12-5/8"	7/8"-18-UNS-2A		76.0	44.0				22

45° Elbow o-ring swivel male fitting
Raccordo maschio o-ring girevole curva 45°

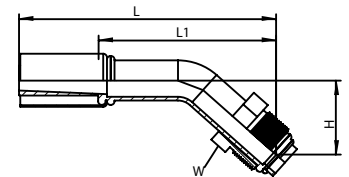

Code Codice	Hose size 1 Dim. tubo 1	Threading Filettatura	Threading 2 Filettatura 2	L ±2.5	±2.5 L1	±2.5 L2	H±2.5	V±2.0	W
110SR976	10-1/2"	7/8"-18-UNS-2A		102.5	71.8		30.0		22

90° Elbow o-ring swivel male fitting
Raccordo maschio o-ring girevole curva 90°

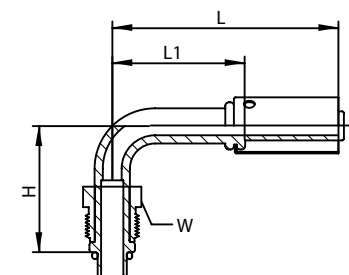

Code Codice	Hose size 1 Dim. tubo 1	Threading Filettatura	Threading 2 Filettatura 2	L ±2.5	±2.5 L1	±2.5 L2	H±2.5	V±2.0	W
106SR002	06-5/16"	5/8"-18-UNF-2A		68.0	40.8		36.5		17
106RR002	06-5/16"	5/8"-18-UNF-2A		68.0	40.8		36.5		17
108SR060	08-13/32"	3/4"-18-UNF-2A		79.0	48.8		48.0		22
108RR060	08-13/32"	3/4"-18-UNF-2A		79.0	48.8		48.0		22
110SR110	10-1/2"	7/8"-18-UNS-2A		87.0	56.3		54.5		22
110RR110	10-1/2"	7/8"-18-UNS-2A		87.0	56.3		54.5		22
112SR110	12-5/8"	7/8"-18-UNF-2A		87.0	55.0		54.5		27

90° Elbow o-ring swivel male fitting with high pressure valve
Raccordo maschio o-ring girevole curva 90° valvola alta pressione

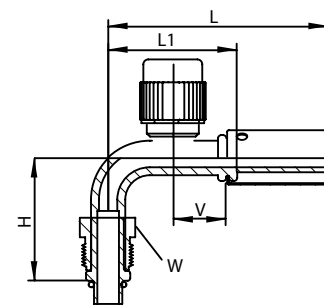

Code Codice	Hose size 1 Dim. tubo 1	Threading Filettatura	Threading 2 Filettatura 2	L ±2.5	±2.5 L1	±2.5 L2	H±2.5	V±2.0	W
106SR003	06-5/16"	5/8"-18-UNF-2A		68.0	40.8		36.5	16.0	17
108SR200	08-13/32"	3/4"-18-UNF-2A		79.0	48.8		48.0	16.0	22

90° Elbow o-ring swivel male fitting with low pressure valve
Raccordo maschio o-ring girevole curva 90° valvola bassa pressione

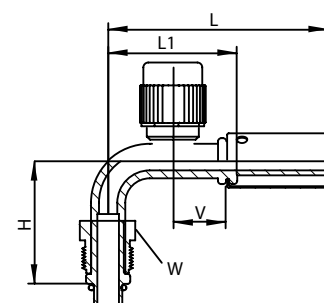

Code Codice	Hose size 1 Dim. tubo 1	Threading Filettatura	Threading 2 Filettatura 2	L ±2.5	±2.5 L1	±2.5 L2	H±2.5	V±2.0	W
110SR200	10-1/2"	7/8"-14-UNF-2B		87.0	56.3		54.5	16.0	22

180° Elbow o-ring swivel male fitting
Raccordo maschio o-ring girevole curva 180°

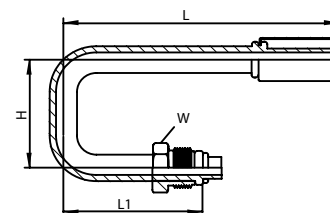

Code Codice	Hose size 1 Dim. tubo 1	Threading Filettatura	Threading 2 Filettatura 2	L ±2.5	±2.5 L1	±2.5 L2	H±2.5	V±2.0	W
106SR962	06-5/16"	5/8"-18-UNF-2A		104.5	77.3	53.3	42.0		17

Straight o-ring fixed male fitting
Raccordo maschio fisso o-ring dritto

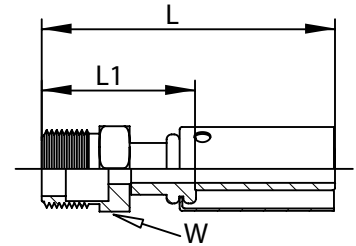

Code Codice	Hose size 1 Dim. tubo 1	Threading Filettatura	Threading 2 Filettatura 2	L ±2.5	±2.5 L1	±2.5 L2	H±2.5	V±2.0	W
106SR029	06-5/16"	5/8"-18-UNF-2A		56.0	28.8				17
106RR029	06-5/16"	5/8"-18-UNF-2A		56.0	28.8				17
108SR214	08-13/32"	3/4"-16-UNF-2A		68.0	37.8				22
110SR042	10-1/2"	7/8"-14-UNF-2A		73.0	42.3				24
112SR042	12-5/8"	7/8"-14-UNF-2A		70.0	38.0				24

Straight o-ring fixed male fitting with counter nut bulkhead
Raccordo maschio fisso o-ring dritto con controdado passa parete

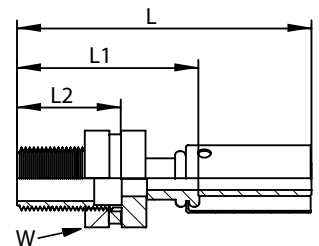

Code Codice	Hose size 1 Dim. tubo 1	Threading Filettatura	Threading 2 Filettatura 2	L ±2.5	±2.5 L1	±2.5 L2	H±2.5	V±2.0	W
106SR950	06-5/16"	5/8"-18-UNF-2A		75.5	48.3		25.5		24
106RR950	06-5/16"	5/8"-18-UNF-2A		75.5	48.3		25.5		24
108SR951	08-13/32"	3/4"-16-UNF-2A		112.5	82.3		26		29
110SR949	10-1/2"	7/8"-14-UNF-2A		83.0	52.3		25.5		29
110RR949	10-1/2"	7/8"-14-UNF-2A		83.0	52.3		25.5		29

90° Elbow o-ring fixed male bulkhead fitting
Raccordo maschio fisso o-ring 90° passa parete

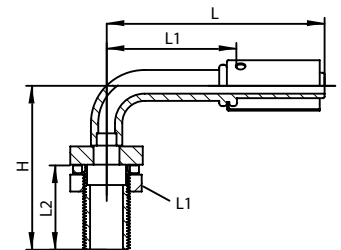

Code Codice	Hose size 1 Dim. tubo 1	Threading Filettatura	Threading 2 Filettatura 2	L ±2.5	±2.5 L1	±2.5 L2	H±2.5	V±2.0	W
106SR951	06-5/16"	5/8"-18-UNF-2A		68.7	41.5	25.5	55.0		24
108SR948	08-13/32"	3/4"-16-UNF-2A		80.5	50.3	26	58.0		29
110SR948	10-1/2"	7/8"-14-UNF-2A		85.2	54.5	25.5	64.0		29